

## Mantel Systems

*Top Off Windows and Garage Doors with Style!*

### Garage Door Length

- Available in 120" (10') base length for garage door and wide window applications
- Endcaps can be used to finish siding or brick applications
- Create a classic design with the Mantel System with a Plain Cover Strip or add the Dentil Strip for a richer effect
- Add the Keystone to join two Mantel Systems over a two-car garage door or for decorative effect over a standard opening
- Cellwood® Mantel Systems are available in White, and can be painted for a custom look
- Constructed of low-maintenance, weather-resistant materials

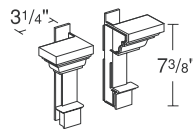

**SDGENCAP**  
Siding Endcaps

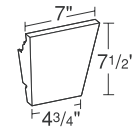

**KEYSTN**  
Keystone for  
Mantel system

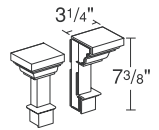

**BRKENDCAP**  
Brick Endcaps

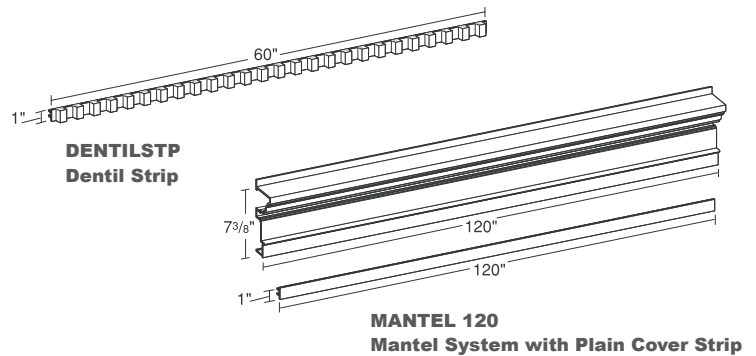

### Order Guide

- Measure the width of the door or window and order the appropriate widths
- Order one Mantel and one set of appropriate (brick/siding) Endcaps for garage door spans 10' wide and narrower
- Order two Mantels, one set of appropriate (brick/siding) Endcaps and one Keystone for applications over 10'

### Window & Entry Door Length

- Choose from 36", 40" or 44" base lengths for standard window widths
- Endcaps are available to create narrower Mantel Systems
- Available in a clean, classic design or with Dentil strip
- Add the Keystone for decorative effect
- Cellwood® Mantel Systems are available in White, and can be painted for a custom look
- Constructed of low-maintenance, weather-resistant materials



**KEYSTONE**  
Keystone

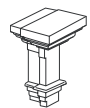
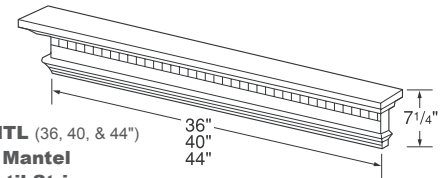

**ENCAP**  
Endcap

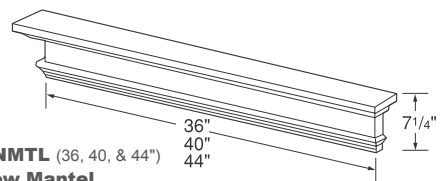

### Order Guide

- Measure the width of the window to determine the appropriate item to order (36", 40" or 44")
- Order one Endcap if you need to create a narrower mantel system
- Order one keystone to create a wider mantel system

## Door Surrounds

*Create an Inviting Entrance!*

- Pilaster Sets are available in 96" and 144" kits to fit most standard height entrances
- Use the classic Door Surround Mantel for a simple design statement or combine it with the Pediment Set for a stately effect over the top of the doorway
- Add the Door Mantel Overlay to join two Door Surround Systems together for applications over wider doorways
- Constructed of highly durable polystyrene for long-term wearability
- Cellwood® Door Surround Systems are available in White, and can be painted for a custom look
- Constructed of low-maintenance, weather-resistant materials



### Order Guide

- Measure the height of the entryway and order the appropriate Pilaster Set
- Measure the width of the doorway and add 15" in order to cover the Pilasters on each side of the door
- Order one Door Surround Mantel to create a classic design
- For a grand design statement in a standard sized doorway, order one Door Surround Mantel and one Pediment Set
- Order one Door Surround Mantel to create a classic design statement in a standard sized doorway
- Order two Door Surround Mantels and one Door Mantel Overlay for applications in doorways wider than 3'

**PEDIMENTST**  
Pediment Set

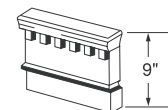
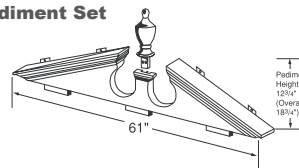

**MANTELOVLY**  
Door Mantel Overlay  
Length: 10 1/2"

**MANTEL**  
Door Surround Mantel

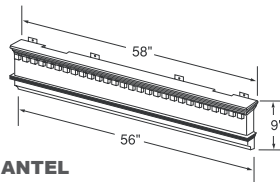

96" or 144"

**PILASTER 96/144**  
Pilaster Set  
Pilaster Set includes:  
2 Pilasters  
6 Mounting Clips  
2 Pilaster Caps  
2 Pilaster Bases

## Dentil Moldings

*Add a Unique and Distinctive Look!*

- Dentil Moldings available in standard 12' lengths
- Add instant architectural detail by emphasizing the rooflines, frieze trim, or adding to soffit and siding applications
- Use the Dentil Molding End Blocks to finish ends, seams or corners
- Constructed of high-impact, fade-resistant vinyl
- Available in White only

**DENTILMD45**  
Dentil Molding

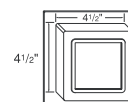
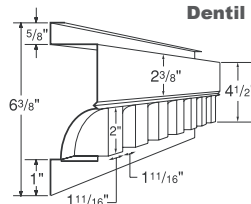

**DENTILBK45**  
End Block



### Order Guide

- Measure the length of the element you wish to enhance and order the appropriate linear feet
- Order the number of Dentil Blocks you need to finish the ends of the application